



NT1003 Controller/Receiver

- ◆ Accepts up to 20 fobs
- ◆ Suitable for motors with loading up to 300w
- ◆ Key fob compatible
- ◆ Deadman on/off function
- ◆ Manual key-switch function
- ◆ Shock proof relays ideal for Tubular Motors
- ◆ Industry standard CPU
- ◆ ABS ultraviolet-resisting plastic housing



NT1004 Controller/Receiver

- ◆ Plug in Terminals
- ◆ Accepts up to 20 fobs
- ◆ Suitable for motors with loading up to 300w
- ◆ Key fob compatible
- ◆ Deadman on/off function
- ◆ Manual key-switch function
- ◆ Shock proof relays ideal for Tubular Motors
- ◆ Industry standard CPU
- ◆ ABS ultraviolet-resisting plastic housing

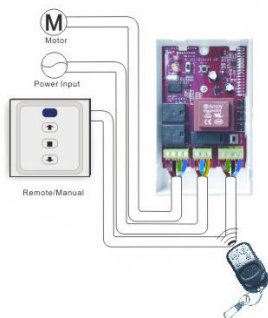



NT1005 4 Way Group Controller/Receiver

- ◆ Suitable for motors with loading up to 300w and external light fittings up to 200w
- ◆ Handset compatible
- ◆ Control range up to 200m
- ◆ Shock proof relays
- ◆ Manual key-switch function

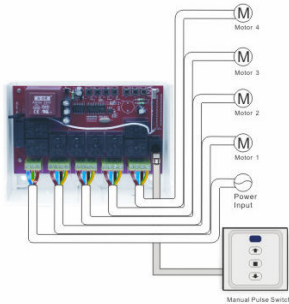

NT1006 Controller/Receiver with Photocell Function

- ◆ Plug In terminals
- ◆ Key fob compatible
- ◆ Accepts up to 20 Fobs
- ◆ Suitable for motors with loading to 300w
- ◆ Deadman on/off function
- ◆ Shock proof relays
- ◆ Manual key-switch function

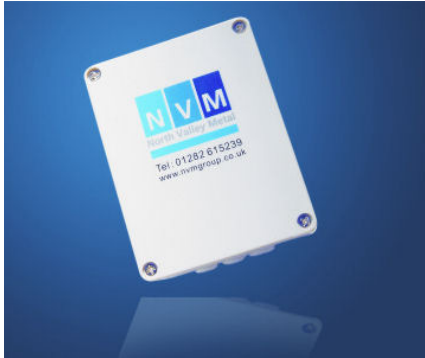

NT1008 Waterproof Controller/Receiver

- ◆ Key fob compatible
- ◆ Accepts up to 20 fobs
- ◆ Suitable for motors with loading up to 300w
- ◆ Intelligent reverse function
- ◆ Deadman on/off function
- ◆ Manual Key-switch function
- ◆ IP65 Rated waterproof box
- ◆ No function buttons on the controller for added security



◆ **NT1009 Fire Shutter Controller/Receiver**

- ◆ Manual switch over-ride for emergency escape
- ◆ Intelligent shutter control reverts to close when manual switch released
- ◆ Suitable for motors with loading up to 30w
- ◆ Low voltage from fire alarm/smoke alarm
- ◆ Will close/open door on receipt of signal
- ◆ Deadman on/off function
- ◆ Intelligent reverse function
- ◆ Manual key-switch function
- ◆ IP65 Rated waterproof box

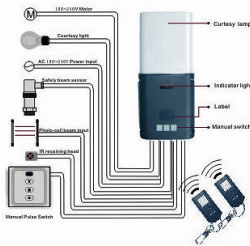

NT1103 Intelligent Garage Door Controller

- ◆ Radio controlled 868Mhz
- ◆ Key fob compatible
- ◆ Safety edge function, with self checking analysis
- ◆ Photcell/light curtain function
- ◆ Deadman/ impulse mode setting
- ◆ Adjustable auto time run function
- ◆ 3 minute integral courtesy light function (repeats from transmitter)
- ◆ External key-switch function
- ◆ Integral up/down/stop buttons
- ◆ Rebound on timed return or stop on block function
- ◆ IP65 rated waterproof box

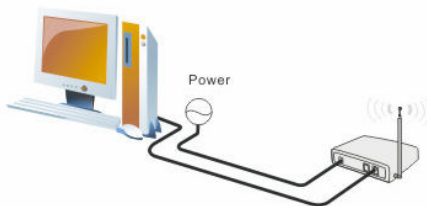

NT1104 Computer Controlled Radio Transmitter

- ◆ RS232 Connectivity for shutters, garage doors, blinds and awnings
- ◆ Compatible with all NVM Tubular Motors and Controllers
- ◆ Adjustable antenna to maintain a stronger signal
- ◆ Sub group control via parallel RJ11 Port connection
- ◆ Operated via software from a PC
- ◆ Up/down/stop switch



NT1105 Radio Receiver

- ◆ External Light and key-switch functions
- ◆ Suitable for motors with loading up to 300w and external light fittings up to 200w
- ◆ Key fob compatible
- ◆ Control range up to 200m
- ◆ Manual key-switch function

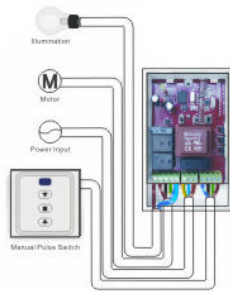

NT1106 Radio Receiver

- ◆ 2 way group control function
- ◆ Manual Key-switch function
- ◆ Suitable for motors with loading up to 300w
- ◆ Key fob compatible
- ◆ Intelligent direction reverse
- ◆ Control range up to 200m
- ◆ Individual or group command function

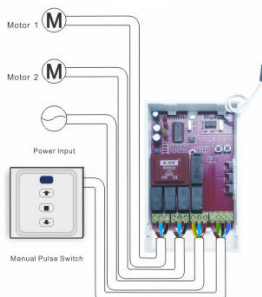



NT1107 Intelligent garage Door Controller

- ◆ Radio controlled 868Mhz or 433.92Mhz activation option
- ◆ Key fob compatible
- ◆ Infrared control activation option
- ◆ Safety edge function, with self checking analysis
- ◆ Photocell or light curtain function
- ◆ Deadman/Impulse mode settings
- ◆ Adjustable auto time return function
- ◆ 3 minute courtesy light function for external light (repeats from transmitter)
- ◆ IP65 rated waterproof box



NT1108 4 Way Group Controller

- ◆ Compatible with all NVM receivers
- ◆ Manual key-switch function
- ◆ Operates 4 motors in group when connected to a radio receiver
- ◆ V1 Fire rated housing

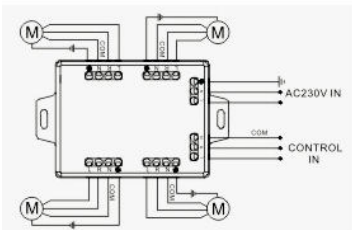



NT1110 4 Way Group Controller

- ◆ Compatible with all NVM receivers
- ◆ Manual key-switch function
- ◆ Operates 4 motors in group when connected to a radio receiver
- ◆ In-door use only

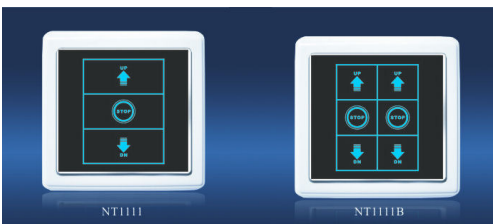
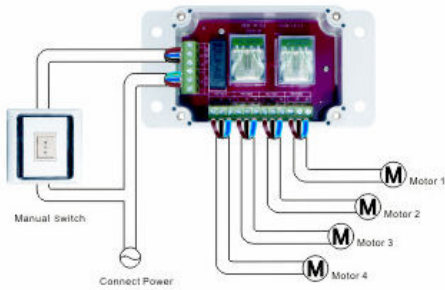

NT1111/NT1111B Receiver Switch with LDC Touch Control

- ◆ Available as either single switch or double switch
- ◆ For in-door use only
- ◆ Supplied complete with mounting box
- ◆ Compatible with all NVM controllers
- ◆ Up/down/stop function
- ◆ Dual switch will function with individual motors or as a group
- ◆ Touch screen buttons
- ◆ 86mm x 86mm

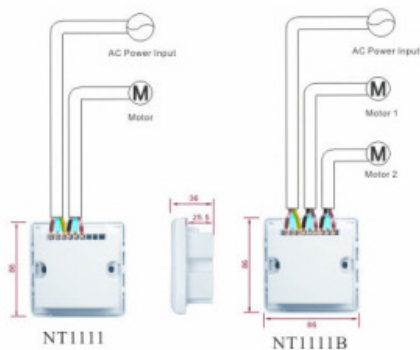

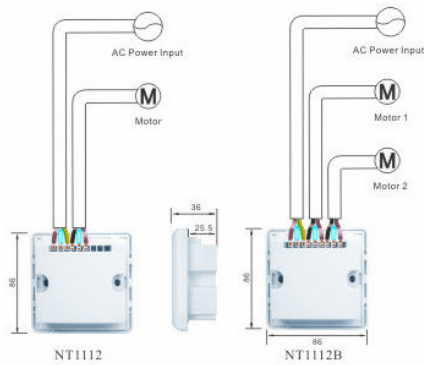

NT1112/NT1112B Wall Mounted Switch

- ◆ Available as either a single switch or double switch
- ◆ For in-door use only
- ◆ Supplied complete with mounting box
- ◆ Compatible with all NVM controllers
- ◆ 86mm x 86mm



NT1113 Wall Mounted Switch with Wireless Function

- ◆ Available as either a single switch or a double switch
- ◆ For indoor use only
- ◆ Supplied complete with mounting box
- ◆ Compatible with all NVM controllers
- ◆ Wireless connectivity

NT1114 Wall Fitted Radio Receiver



- ◆ Multiple timer function that allows timed controlled open/close operation with daily/weekly settings
- ◆ For indoor use only
- ◆ LCD display for time, day, date and year
- ◆ 9 stage multiple time settings
- ◆ Compatible with all NVM controllers
- ◆ Complete with electrical fire protection rating
- ◆ 86mm x86mm

NT1115 Wall Mounted 16 Channel Wireless Switch



- ◆ 16 Channel wireless control
- ◆ Up/down/stop function with LED channel display
- ◆ To operate motors up to 300w
- ◆ Clamp style terminals for ease of wiring

NT1117 Wireless Rocker Switch



- With Dead-man Function
- To suit NVM Controller / Receivers NT1004, NT1006
- Will work in conjunction with NT1016 Fob Handsets
- Simple to program
- Aesthetically pleasing design
- Very easy to install.

NT1117B Controller / Receiver / Switch



- With Deadman Function
- Operates as a Standard Rocker Switch
- Operates as a Wireless Receiver.
- Accepts up to 20 Standard NT1016 Fob Handsets
- Simple to program
- Aesthetically pleasing design
- Very easy to install.

Group Command

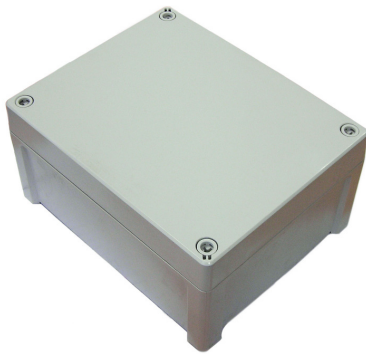

NT1101	6 Way Group Command
NT1101B	4 Way Group Command
NT1101C	8 Way Group Command

- Single Phase Input
- Volt Free Supply To The Keyswitch
- Will Accept Volt Free Control Panel for Remote Control

NT1018 Wall Mounted Remote Control

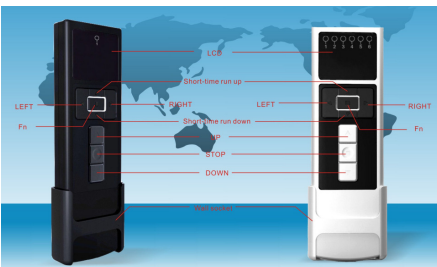

- ◆ Available as either single channel or 6 channel functions
- ◆ All in one button for ease of use
- ◆ Easy up/down/stop and channel switching
- ◆ Wall fitted holder
- ◆ Uses 2 AAA batteries
- ◆ Power saving function giving batteries a 3-5 year life

Ancillary Items



NT1016/NT1103A

NT1016 Key Fob

Compatible with all NVM Controllers NT1004/6/1103

NT1017- Multi-Channel Key Fob

Compatible with all NVM Controllers NT1004/6/1103

T1010 -Wall Mounted Single Channel Handset

NT1011- 2 Channel Handset—Dual Channel or Group Control

NT1012— Wall Mounted 4 Channel Handset

4 channel control or group control



NT1014 Rocker Switch

CONTROLLERS, RECEIVERS & PHOTOCELLS



- NV245** Geba Keyswitch 16 amp—Random Key
- NV245A** Geba Keyswitch 16 amp—Keyed Alike
- NV245C** Geba Keyswitch 32 amp—Random Key
- NV245D** Geba Keyswitch 32 amp—Keyed Alike
- NV245G** Geba Keyswitch 32 amp—Single Pole
- NV245L** Geba Keyswitch 16 amp—2 Pole
- NV245K** Blank Keys for Geba Keyswitches 16 amp

- NV245F** Geba Keyswitch 16 amp—Random Key
Customer Logo Faceplate



- NV245B** NVM Keyswitch 16 amp—Random Key
- NV245M** Blank Keys to suit NVM Keyswitch



- NV245N** Geba Keyswitch 16 amp—Flush Mounted-Random Key
- NV245P** Geba Keyswitch 16 amp—Flush Mounted-Keyed Alike